

(2, 2)

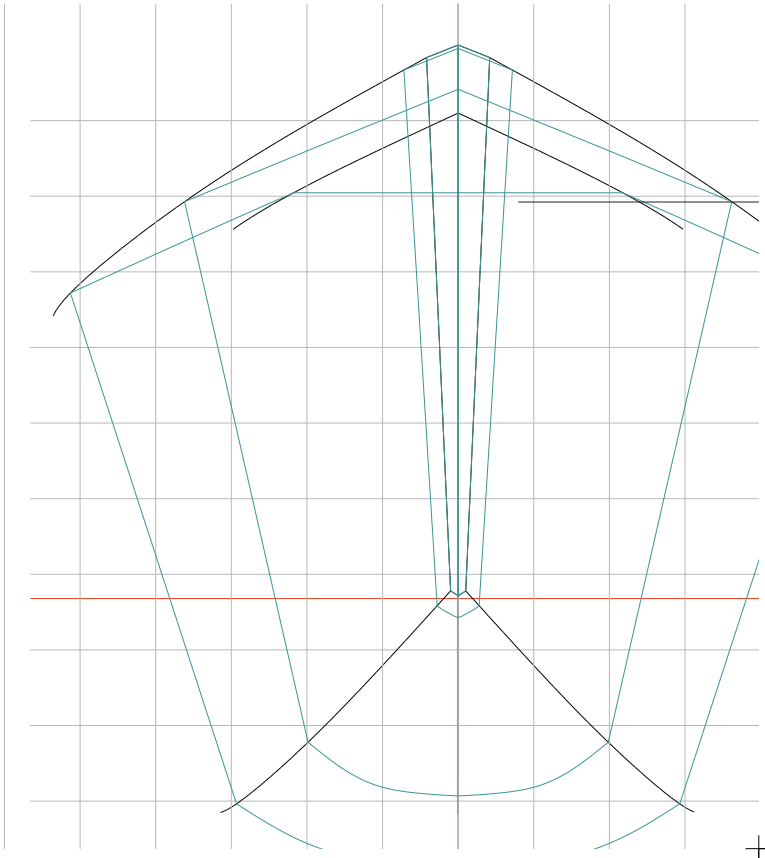

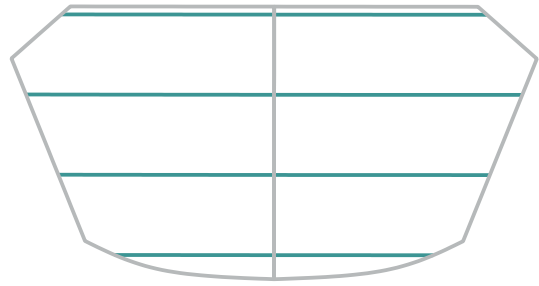

(1, 3)

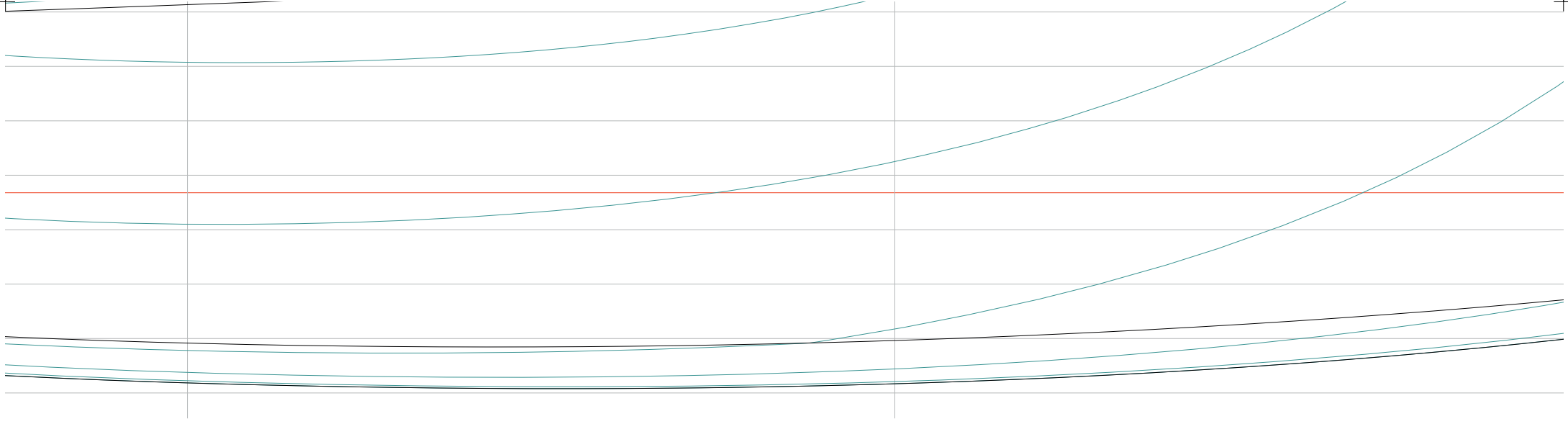
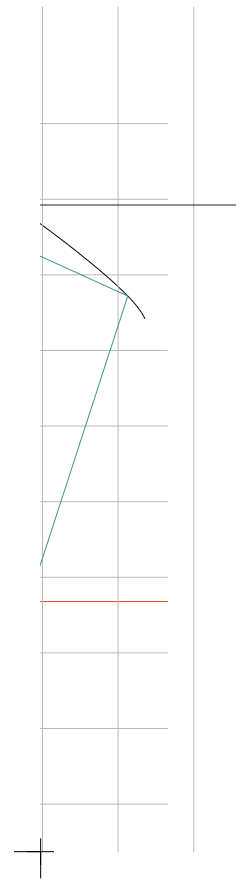
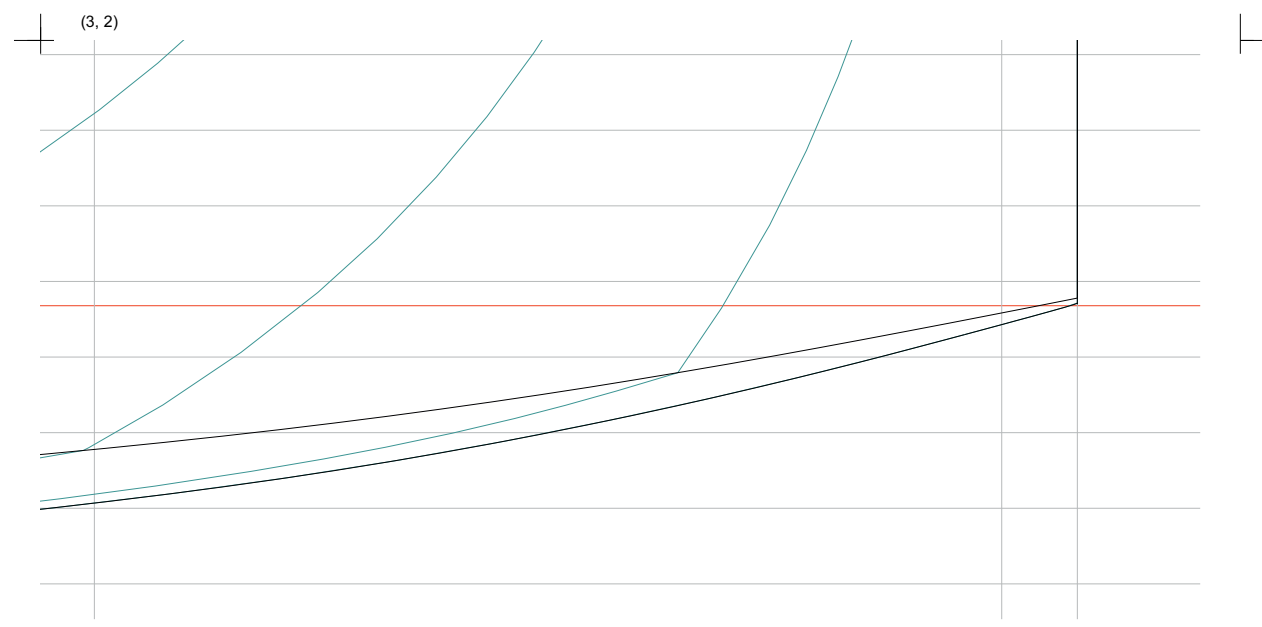
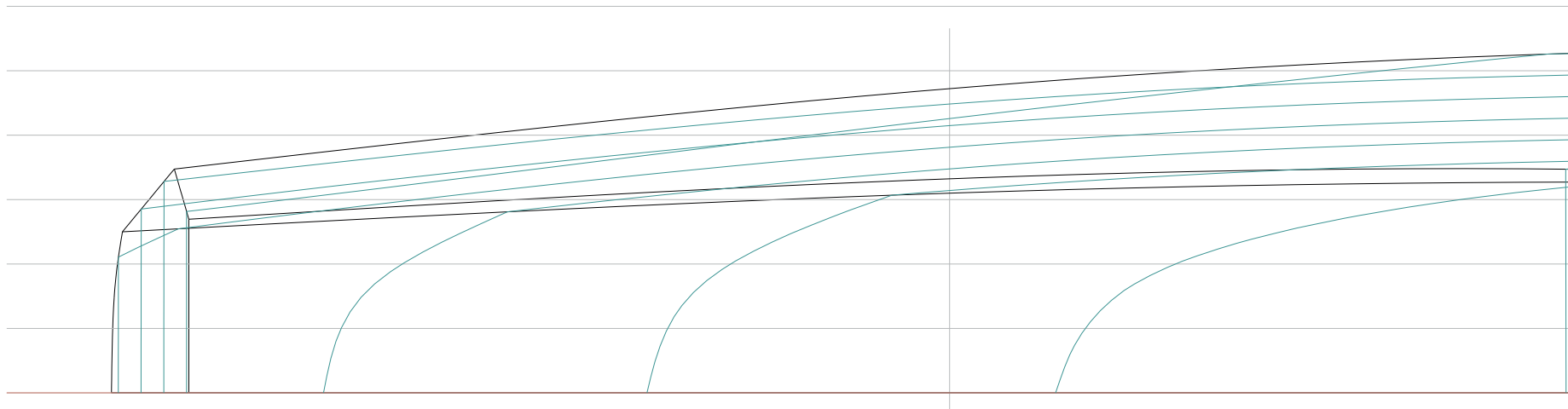

(2, 3)

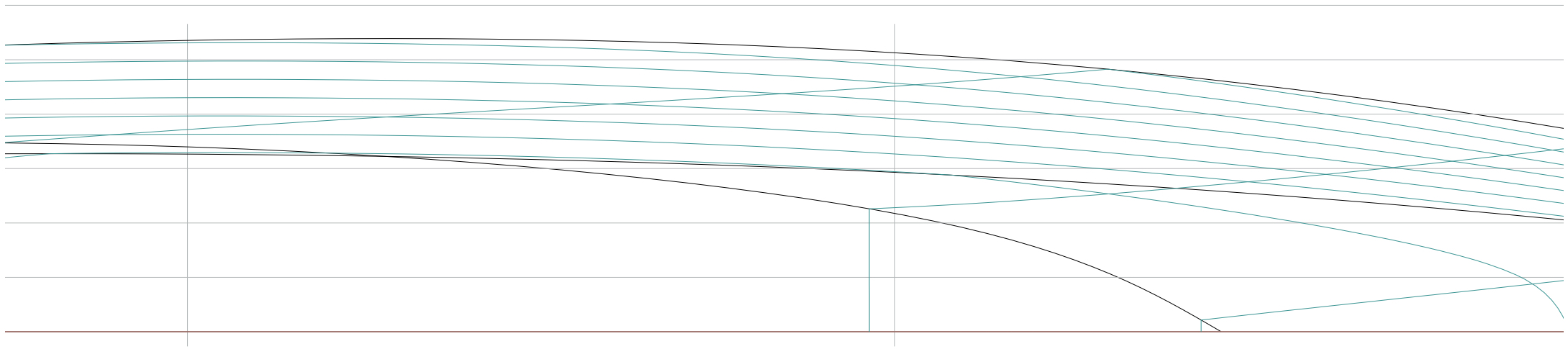
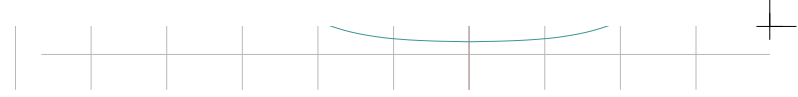

T

T

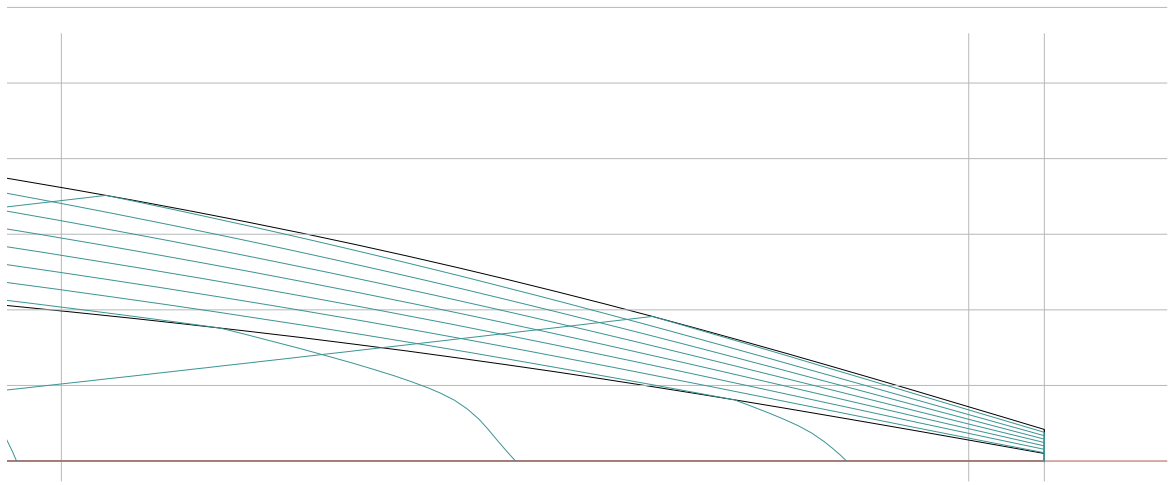

RG-65 Klasse

NeKst Round

Idee: Andreas Hoffmann

Design: Andreas Hoffmann, Joachim Pelka

Plan: Joachim Pelka

Version 1.2 / 29.6.2013

(1, 1)

35 mm

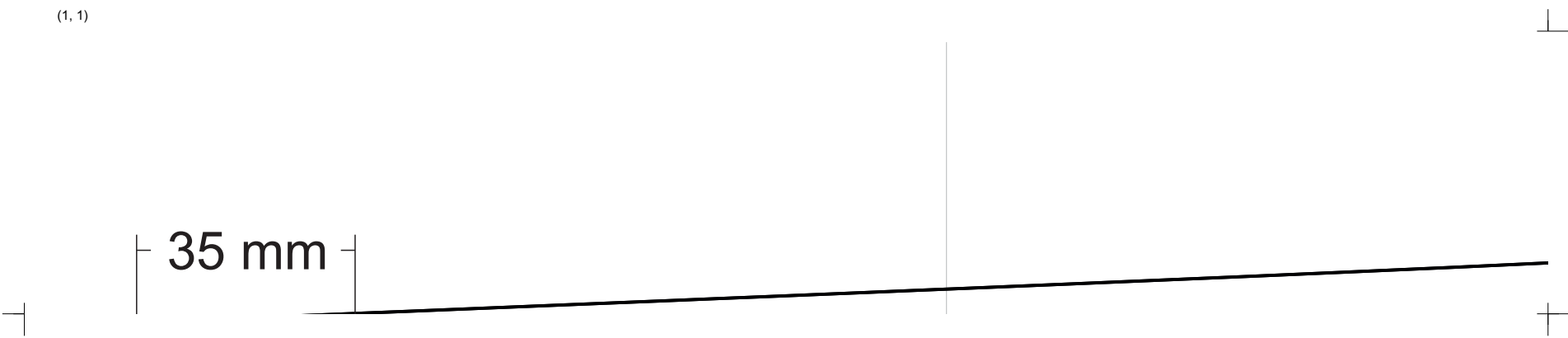

⊥ (2, 1)

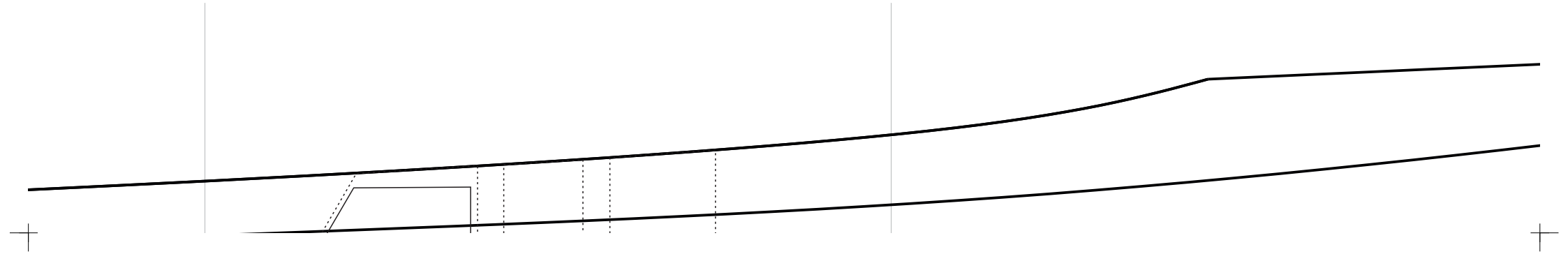

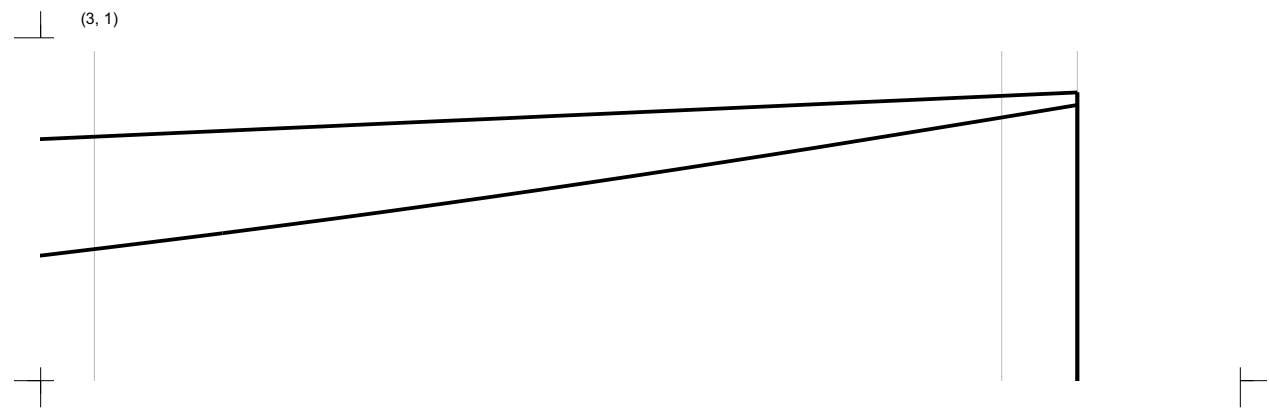

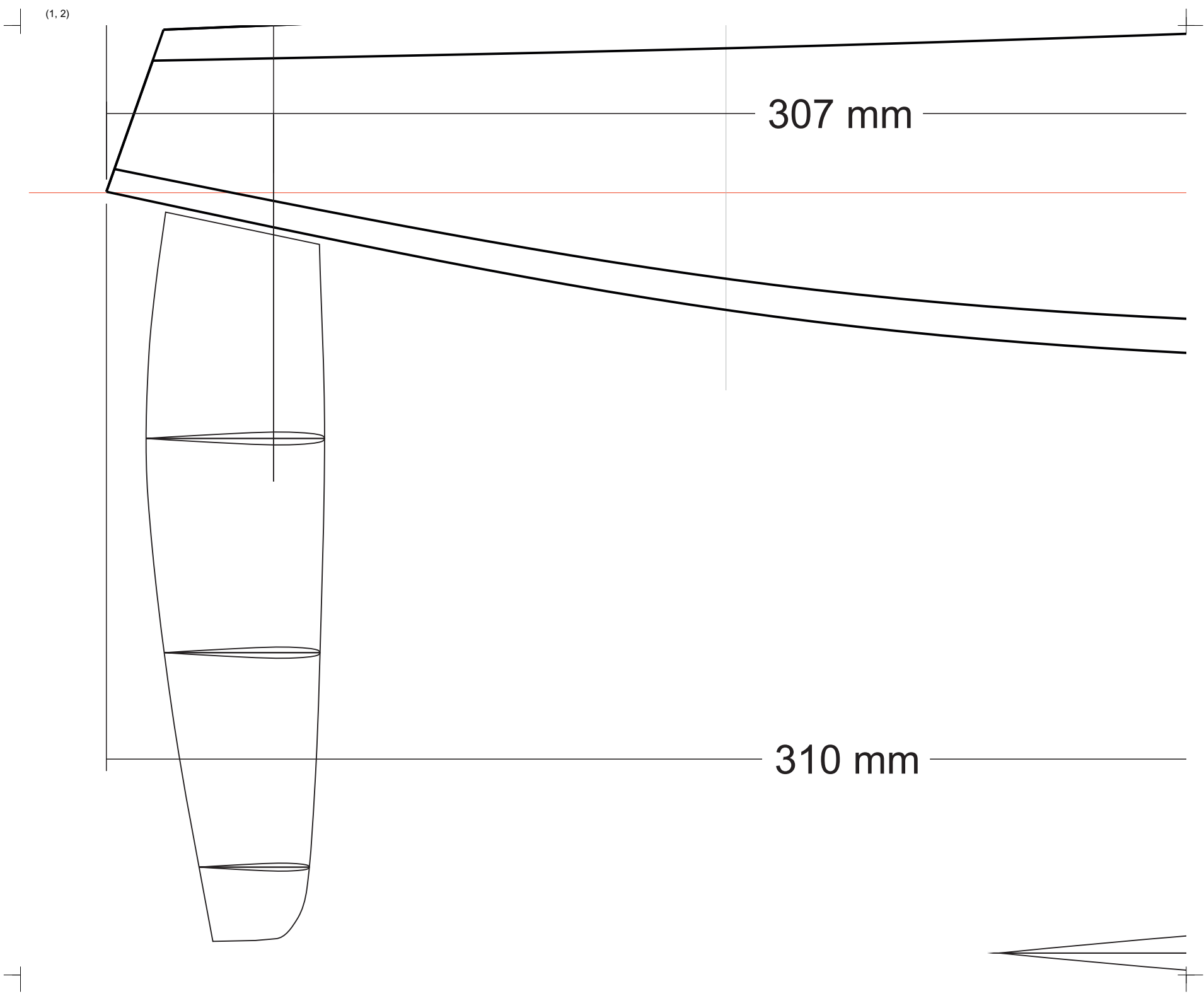

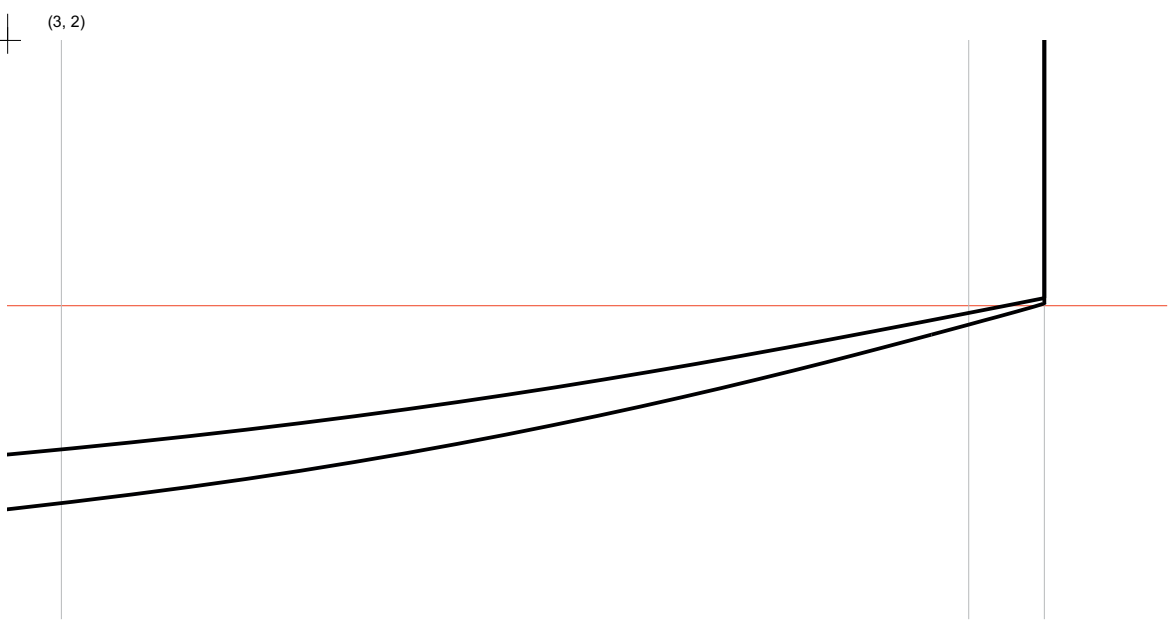

ungsschwerpunkt des Rumpfes

ten und Halterung für das Segelservo

(2, 3)



T

T

RG-65 Klasse

NeKst Round

Idee: Andreas Hoffmann

Design: Andreas Hoffmann, Joachim Pelka

Plan: Joachim Pelka

Version 1.2 / 29.6.2013

Seite 2/11

(1, 1)



⊥ (2, 1)

⊥

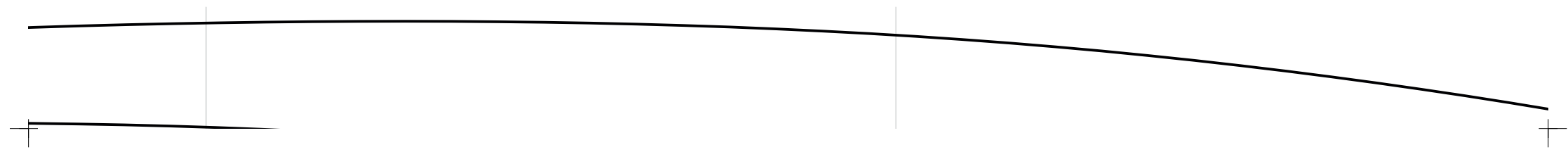

⊥ (3, 1)

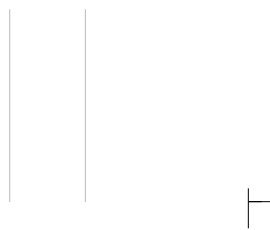
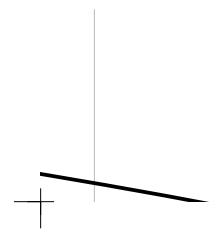

(1, 2)

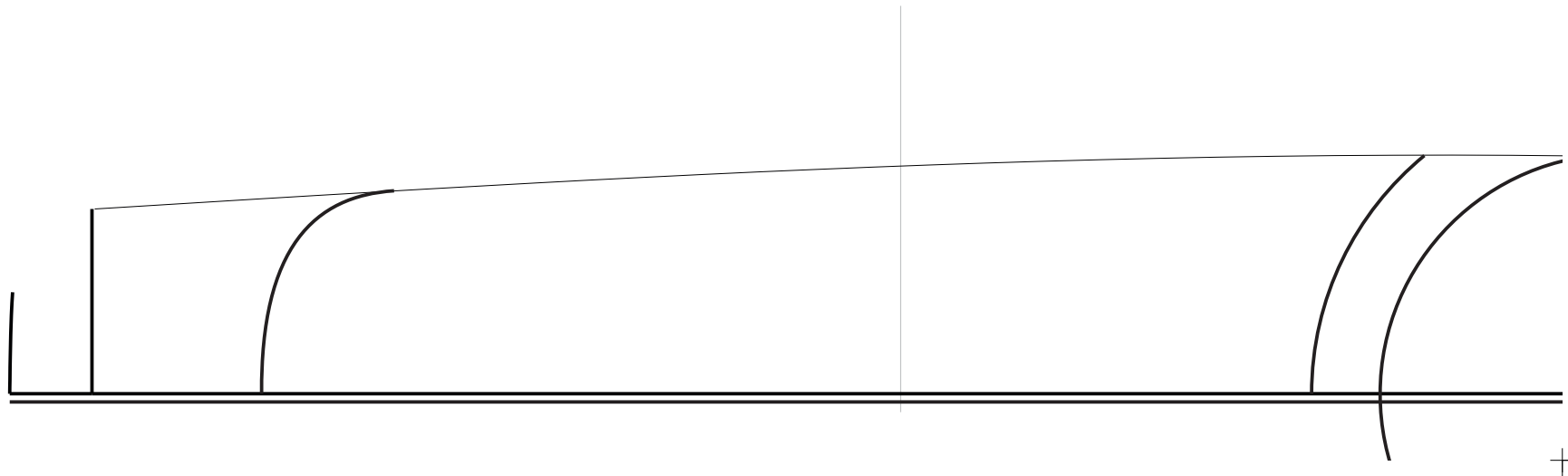
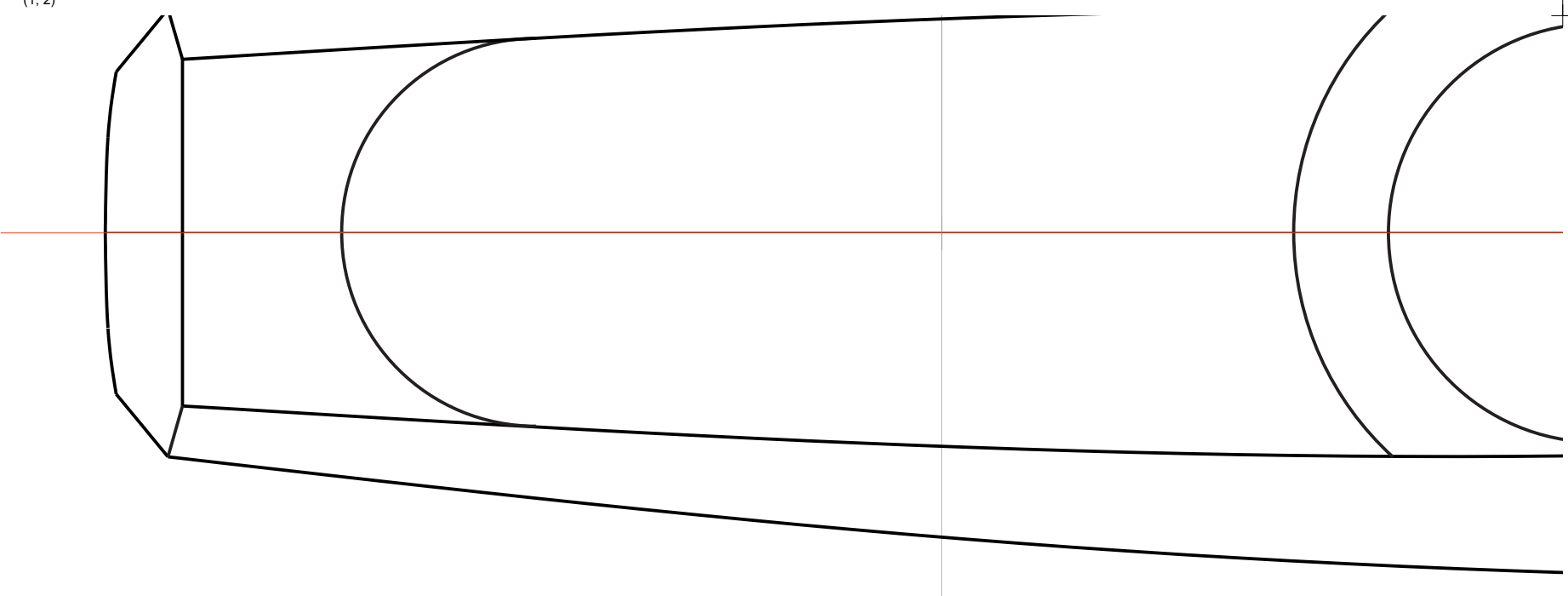

(2, 2)

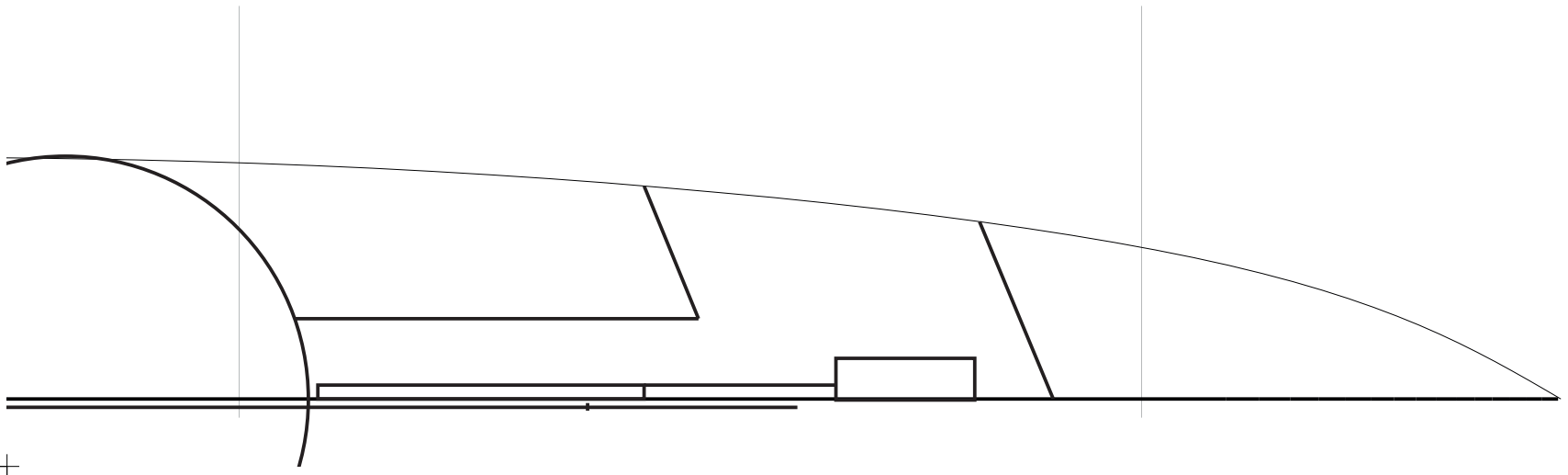
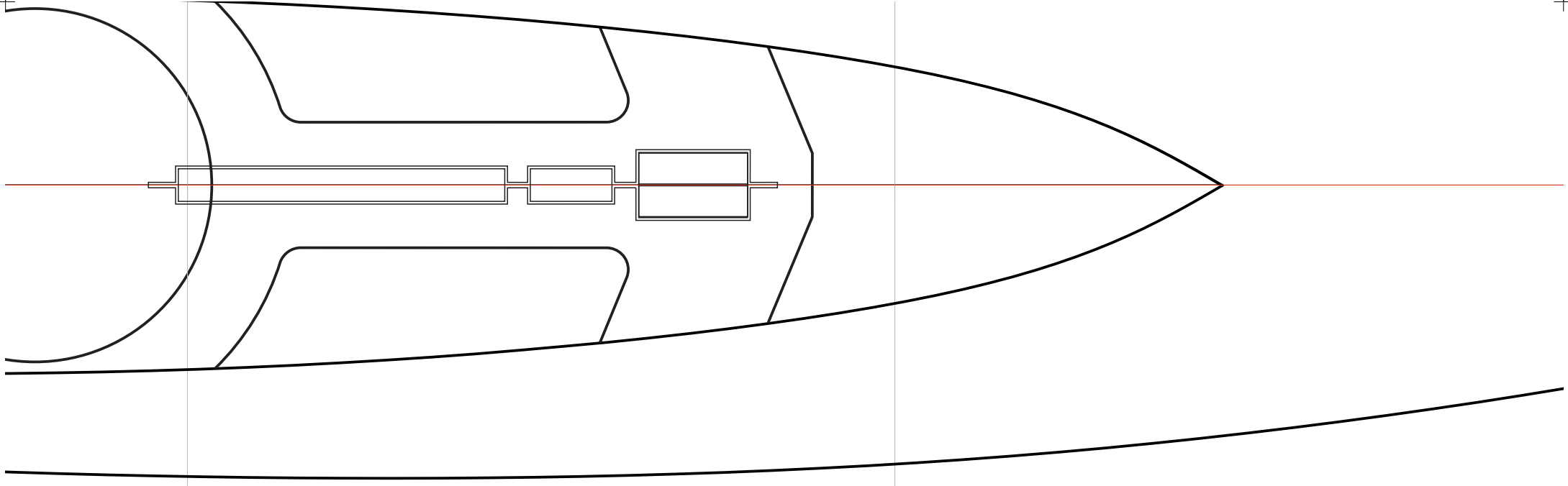

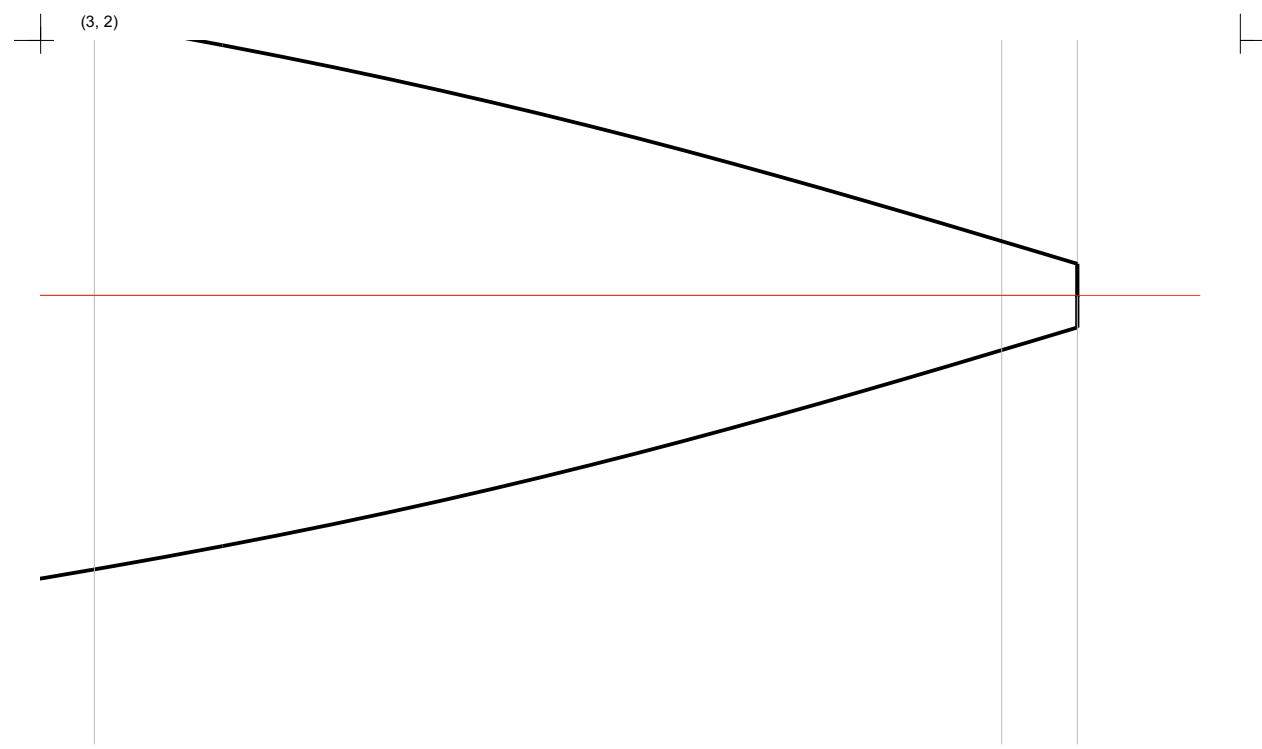

(1, 3)

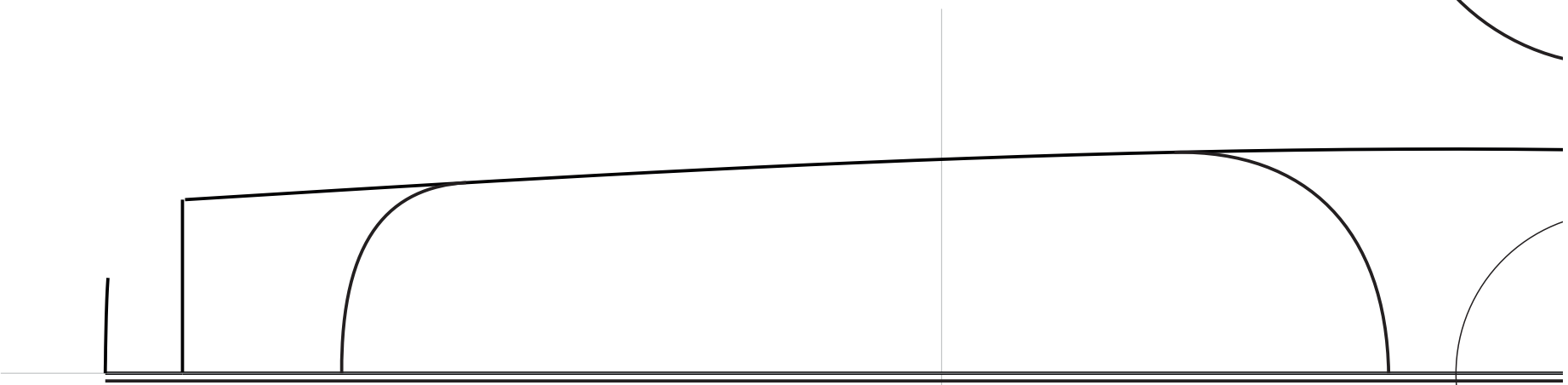
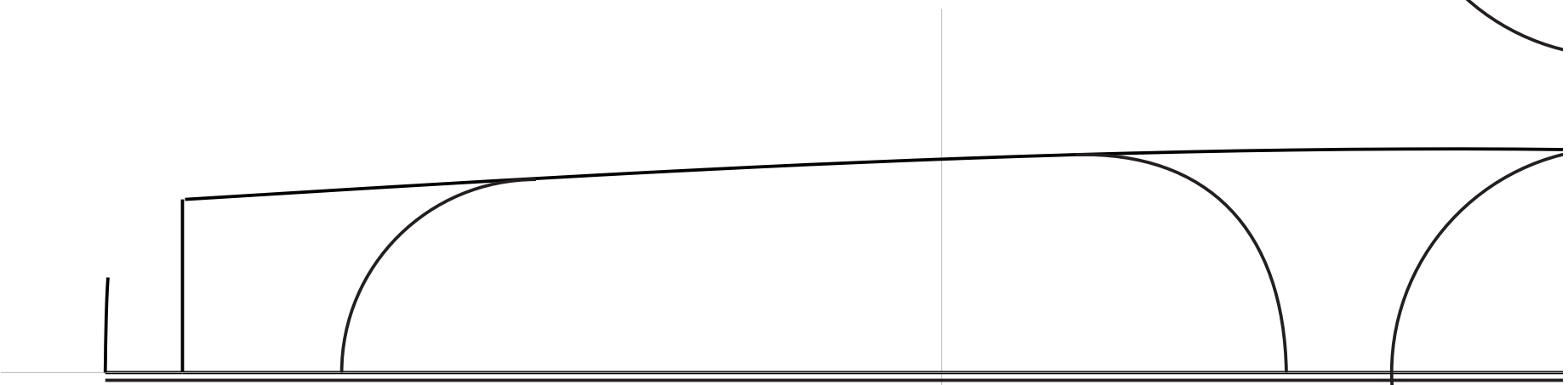

(2.3)

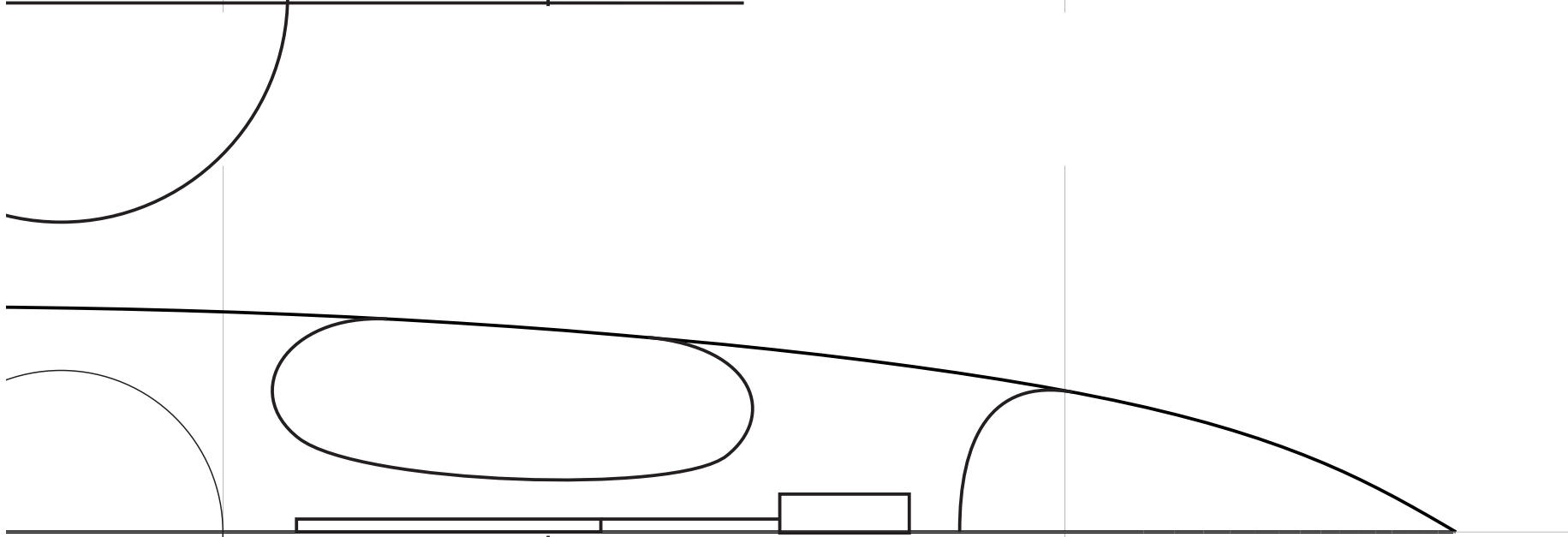
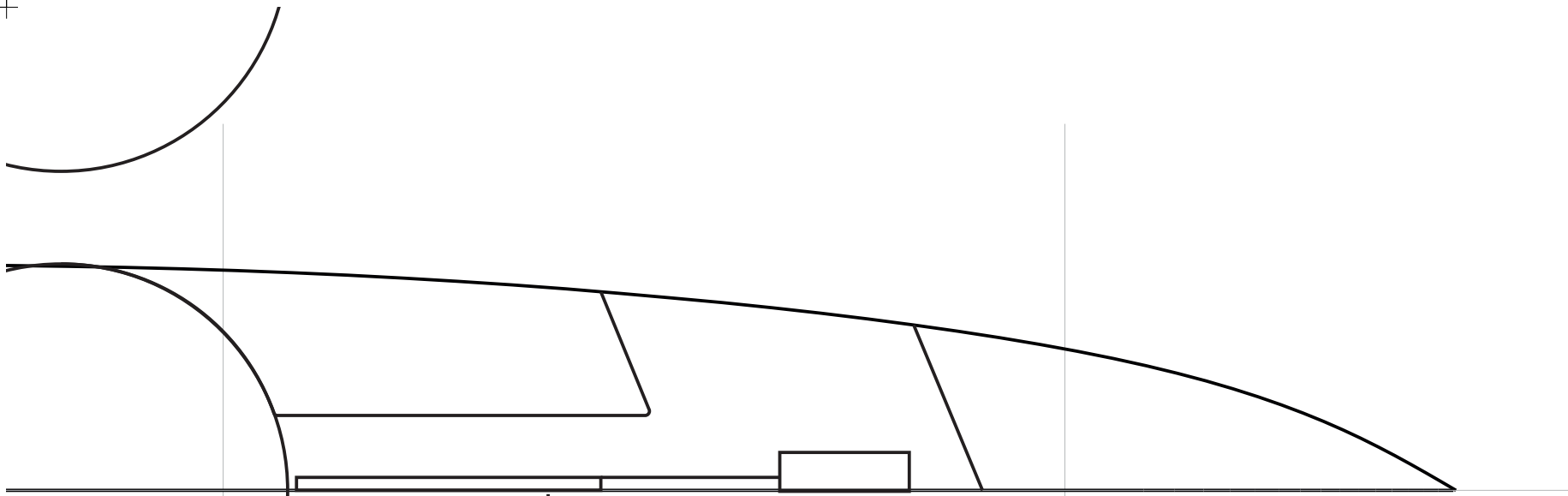



(3, 3)



Deckslayout, verschiedene Varianten



(2.4)



RG-65 Klasse

NeKst Round

Idee: Andreas Hoffmann

Design: Andreas Hoffmann, Joachim Pelka

Plan: Joachim Pelka

Version 1.2 / 29.6.2013

Seite 3/11

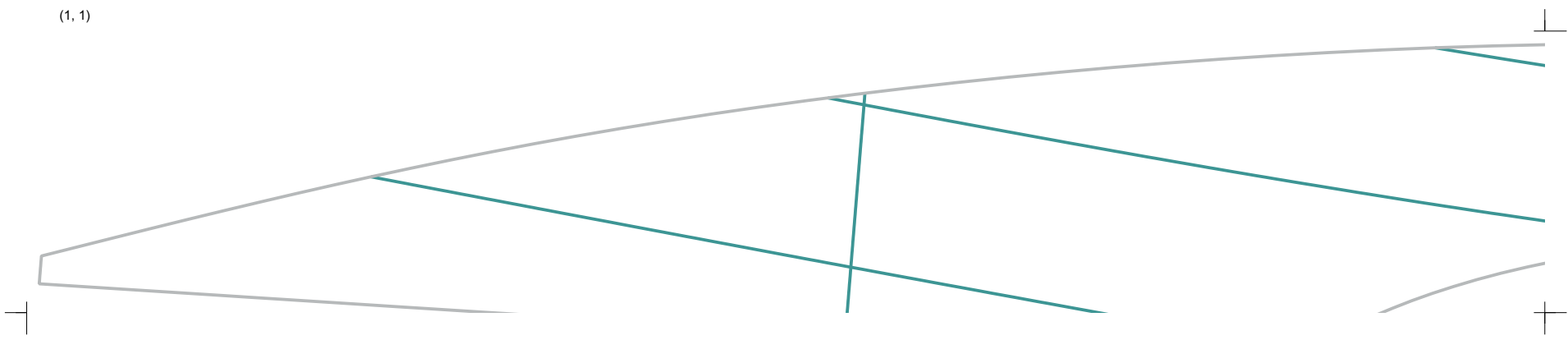

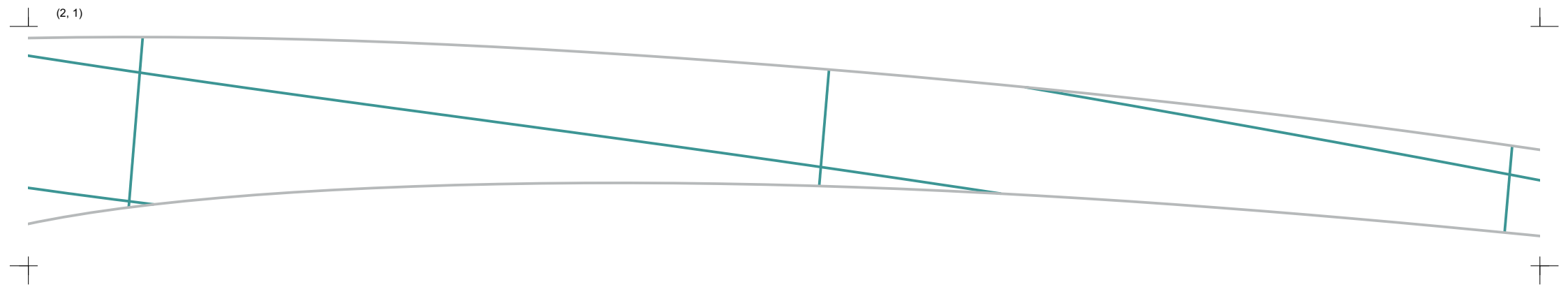

⊥ (3, 1)



⊥

(1, 2)

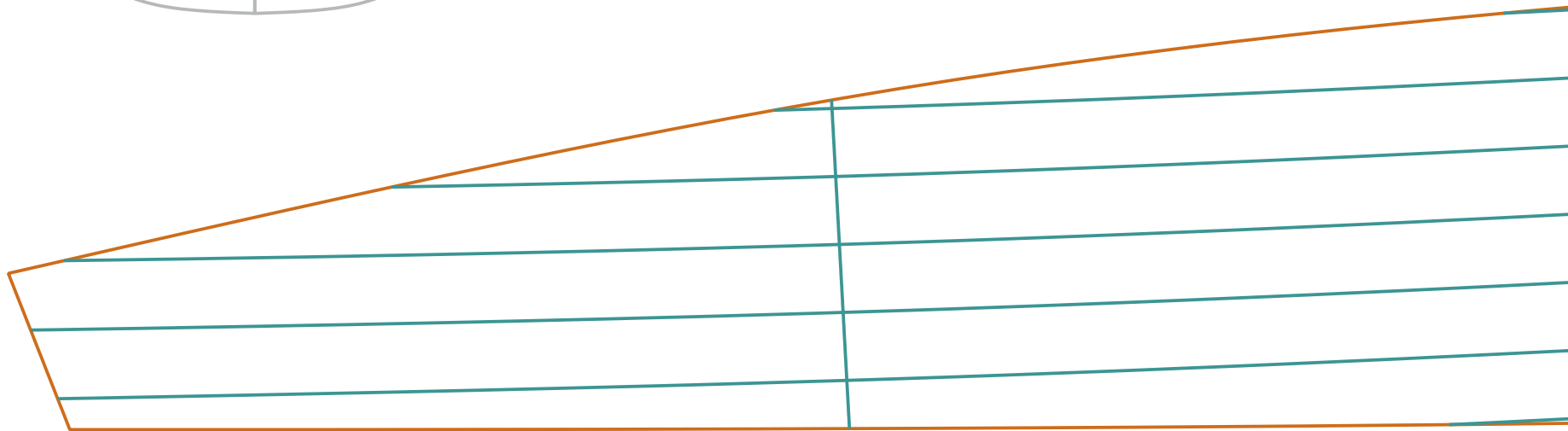
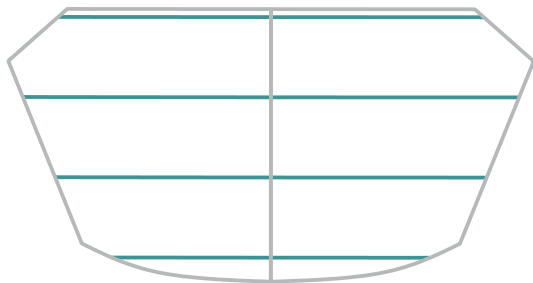
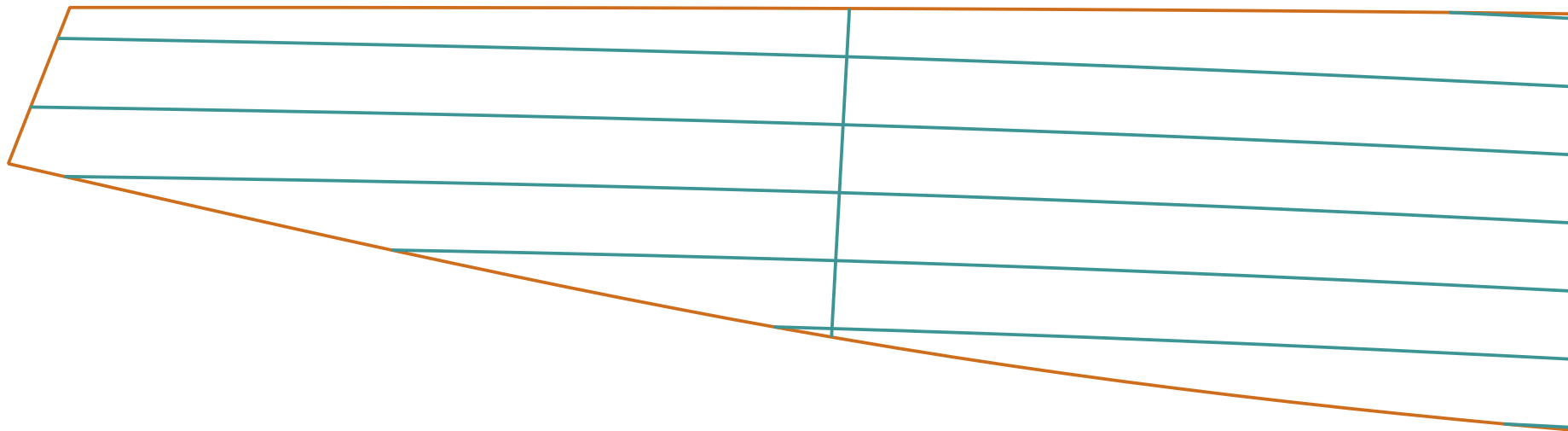

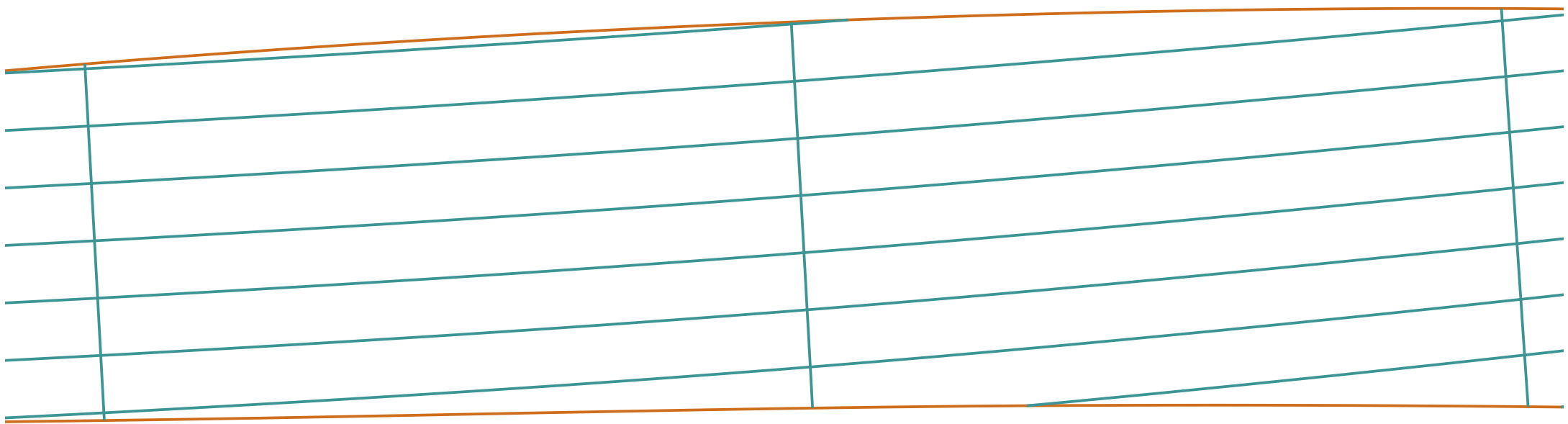
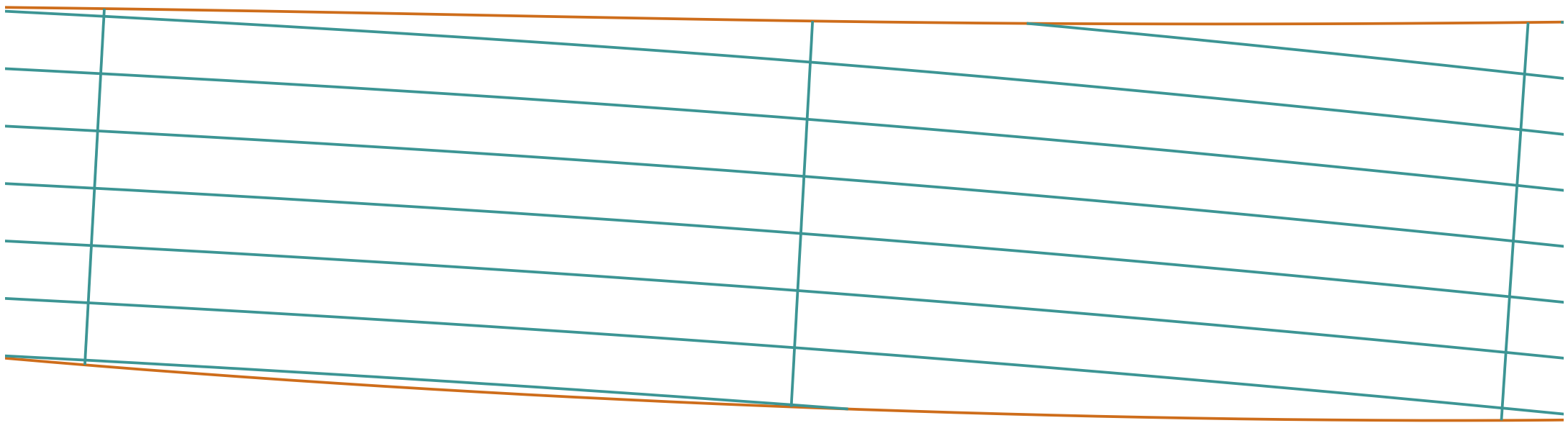

(3, 2)

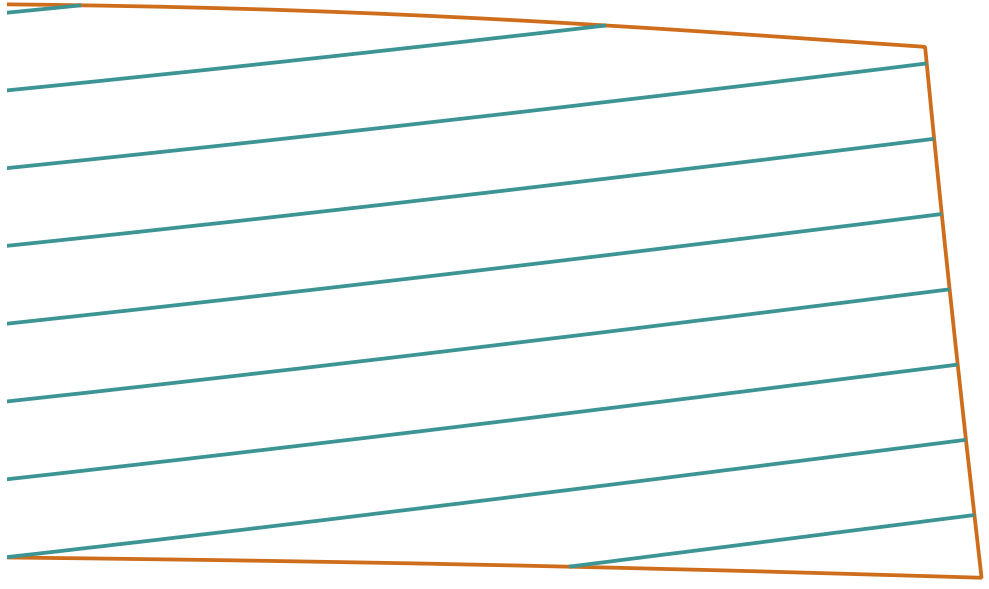
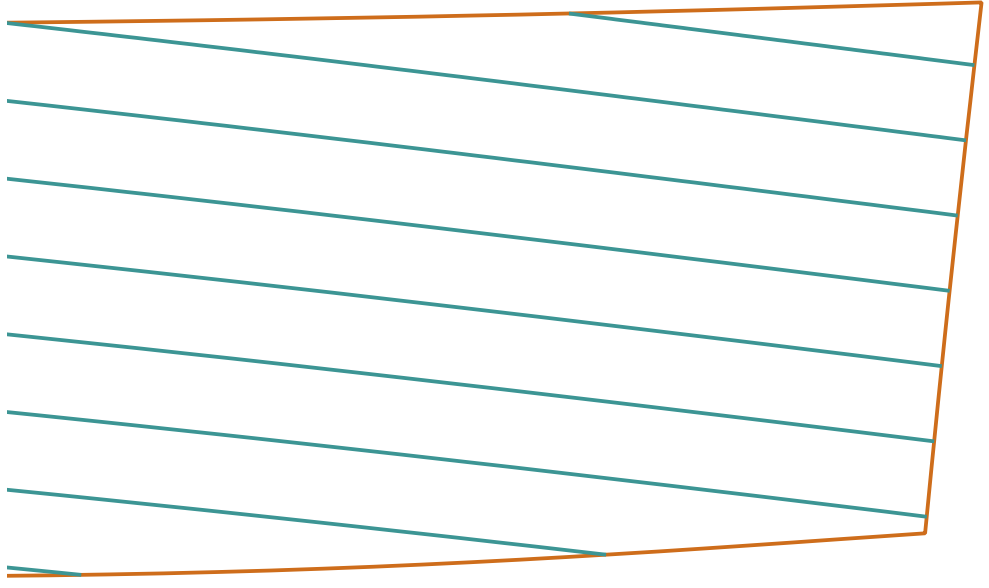

(1, 3)

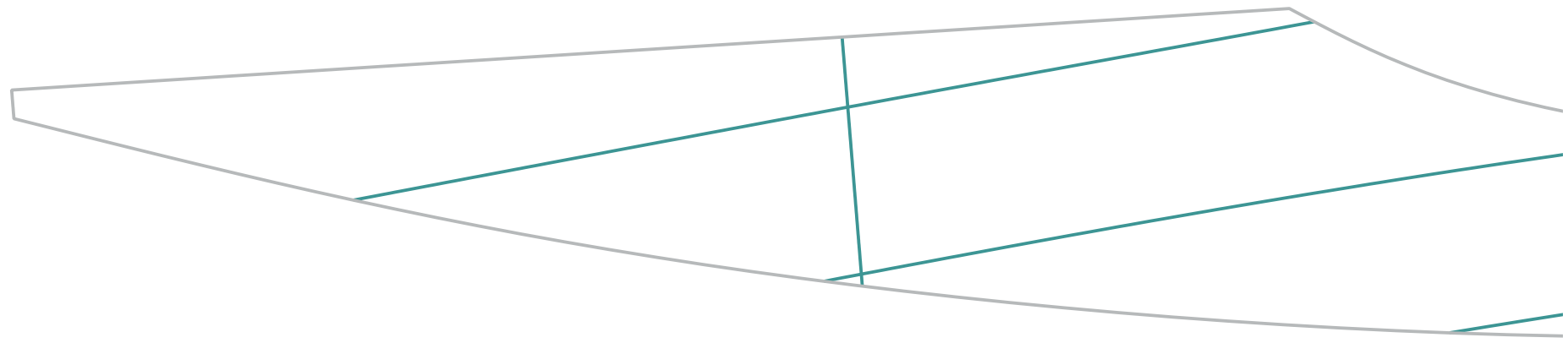

Abwicklung der Seitenplank

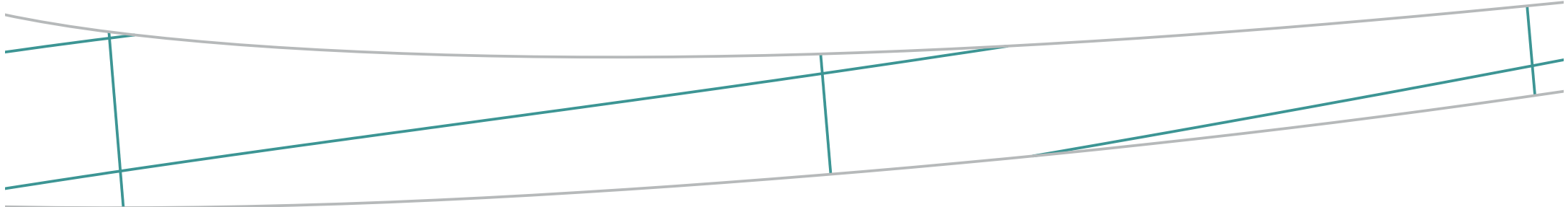

en, des Decks und des Spiegels

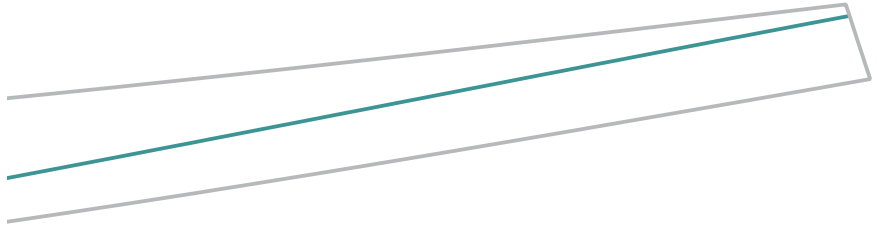

RG-65 Klasse

NeKst Round

Idee: Andreas Hoffmann
Design: Andreas Hoffmann, Joachim Pelka
Plan: Joachim Pelka
Version 1.2 / 29.6.2013

⊥ (2, 4)

⊥

⊥

⊥

